

ECOPHON

OPTA™

CEILING FOR BASIC ACOUSTIC COMFORT



04 ABOUT ECOPHON

06 GOOD ACOUSTICS MATTER EVERYWHERE

08 TOWARDS NET-ZERO ACOUSTICS

10 CEILING FOR BASIC ACOUSTIC COMFORT WITH ECOPHON OPTA™

12 ECOPHON OPTA™ PRODUCT RANGE

12 Opta A

12 Opta E

28 SYSTEM PROPERTIES

Acoustics, technical properties and installation diagrams

Any picture, description, illustration and dimensions contained in this brochure is for information purpose only and is not contractual. This brochure shows Ecophon products and may contain third-party's products. Ecophon shall not be liable for any misprint. Ecophon reserves the right to change product specifications at any time without prior notice. Recommendations of use and installation/assembly, as well as storage, maintenance and indoor environment conditions, must always be respected. Please refer to the applicable technical documentation, such as technical data sheet and installation guidelines. For a comprehensive and up-to-date library of information, including the last version of applicable General Terms and Conditions of Sales, please visit www.ecophon.com

©Saint-Gobain Ecophon AB, 2024-04-05



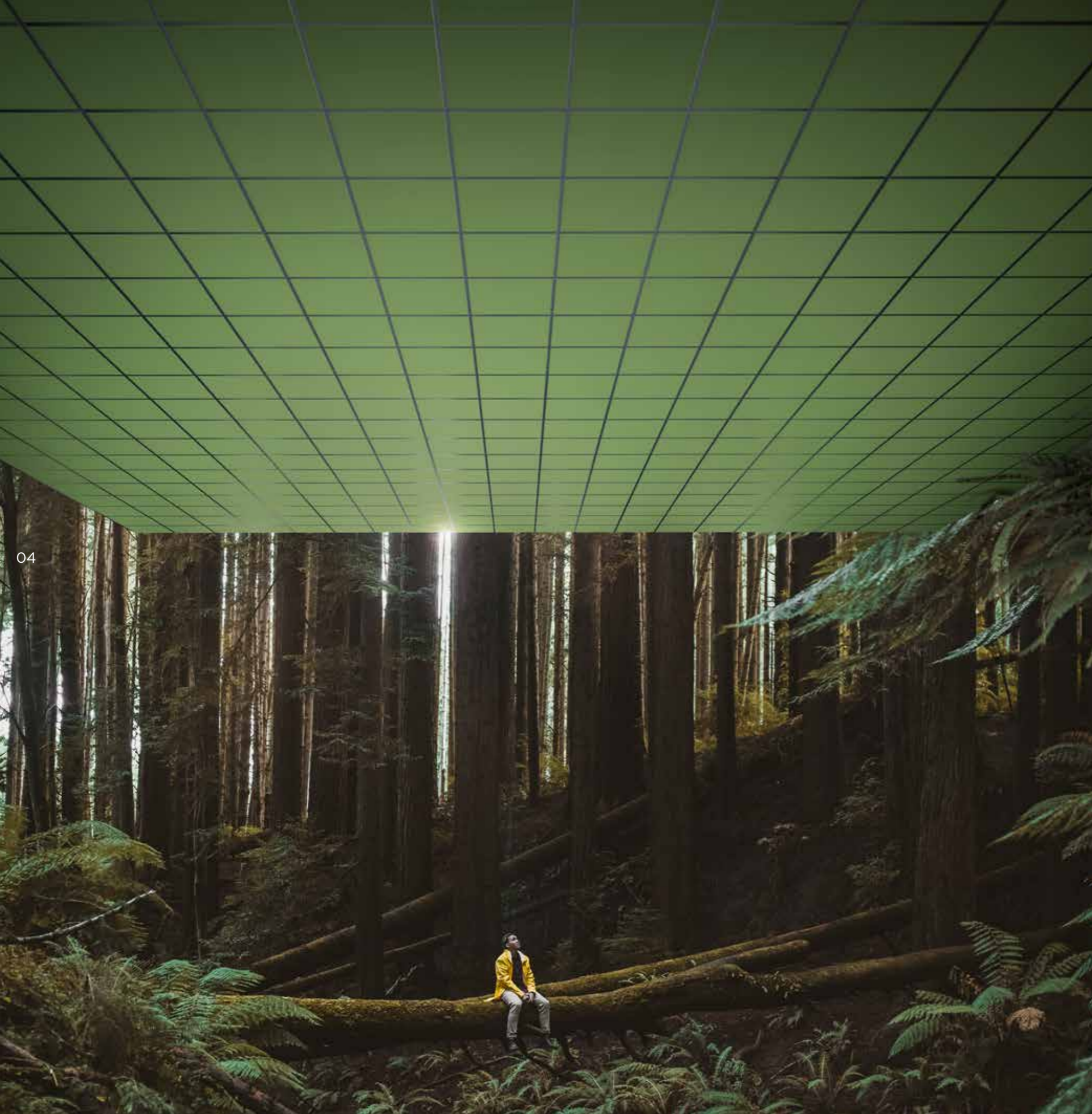

A SOUND EFFECT

ON PEOPLE

Saint-Gobain Ecophon contributes to good indoor environments for working, healing and learning. We do this by developing, manufacturing and delivering acoustic products and systems designed around the natural evolution of human hearing - replicating the outdoor sound experience indoors, because that's just better for people.

Having a sound effect on people, in every way we can, is what we do proudly. That promise makes every one of us a passionate advocate for the importance of room acoustics to people's wellbeing - whatever the space, activity or need.

GOOD ACOUSTICS MATTER EVERYWHERE

The importance of acoustics is underappreciated. Sound impacts us in daily life, and the scientific support for improving our indoor sound environments is well-documented.

And what exactly is an ideal indoor sound environment for people? One based on how we experience sound outside. The human auditory sense is naturally adapted to an outdoor environment where there is not any sound reflections from ceilings and walls.

That's why most of what we do at Ecophon is about replicating the acoustic qualities found in nature for indoor environments. We want to optimise indoor spaces to our natural way of hearing, so that speech and sound is easy to hear and understand, when needed, improving performance and wellbeing.

Usually that starts with the ceiling. A wall-to-wall acoustic ceiling is the easiest way to get a large sound-absorbing surface area into a space, and is usually the best way to reduce sound strength, shorten reverberation times, and increase speech clarity and overall hearing comfort.





TOWARDS

NET-ZERO ACOUSTICS

Sustainability is more than a word – it's a collective movement to protect people and the planet that requires honest commitment and genuine care. That's why Ecophon is building on better materials, transparency, and principles, to name just a few.

We actively support an industry-wide drive to standardised, easy-access Environmental Product Declarations for individual products, rather than product families. Their inclusion of full lifecycle data, from raw material sourcing to end of life, rather than only the favourable stages. A move away from self-declared labels, or non-independently verified sustainability claims. And for any promises of net zero carbon emission targets to be validated by the Science-Based Targets initiative.

If we're going to build a sustainable future, it has to start with an honest approach, high ambition and the best of intentions – to build on better together.

ECOPHON OPTA™

UNIVERSAL SUSPENDED CEILINGS SYSTEM

The Ecophon Opta™ ceiling system is a universal solution for rooms where simple and quick installation is required.

It is an economical solution that meets the most important requirements regarding acoustics, humidity resistance and mechanical strength, while ensuring an attractive appearance of ceiling surfaces.

The tiles are manufactured from high density glass wool. The visible surface is a batch painted glass tissue in white and the back of the tile is covered with glass tissue.

The supporting structure is made of galvanised steel. To obtain the best performance and quality of the system, we recommend using Ecophon Connect™ grid system and accessories.

- Absorption class A
- Clean and tidy appearance
- Economical solution

CLASS A
ACOUSTIC ABSORPTION



PRODUCT RANGE

ECOPHON OPTA™ A

Ecophon Opta™ A has an exposed grid system with each tile individually demountable for easy access to soffit above. For applications requiring an easy-install suspended ceiling to meet the basic functional demands. Opta has a minimum volume purchase requirement, contact Ecophon for more information.

ECOPHON OPTA A

600x600x15
1200x1200x15

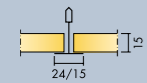

ECOPHON OPTA™ E

Ecophon Opta™ E has a recessed visible grid and a tegular edge design, creating a ceiling with a shadow effect to accentuate each tile and partially conceal the grid system. For applications requiring an easy-install suspended ceiling and meets basic functional demands.

ECOPHON OPTA E

600x600x15
1200x600x15

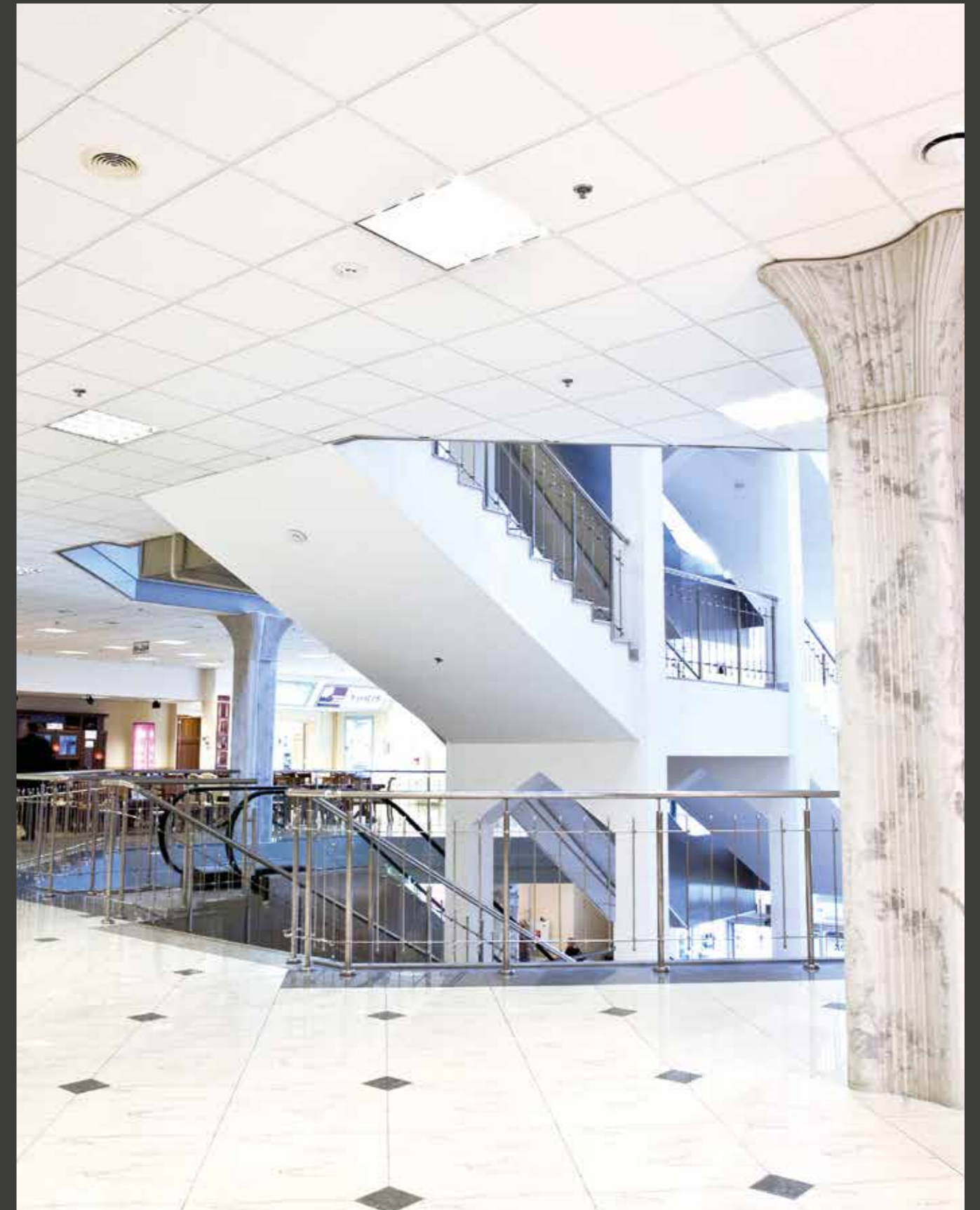
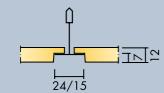



SYSTEM PROPERTIES

ACOUSTICS, TECHNICAL PROPERTIES AND INSTALLATION DIAGRAMS

- 16 Opta A
- 18 Opta E



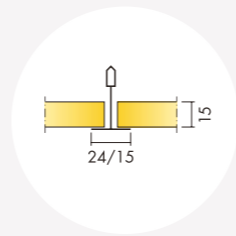

Ecophon Opta A

Acoustic:

Sound Absorption: Test results according to EN ISO 354. Classification according to EN ISO 11654.

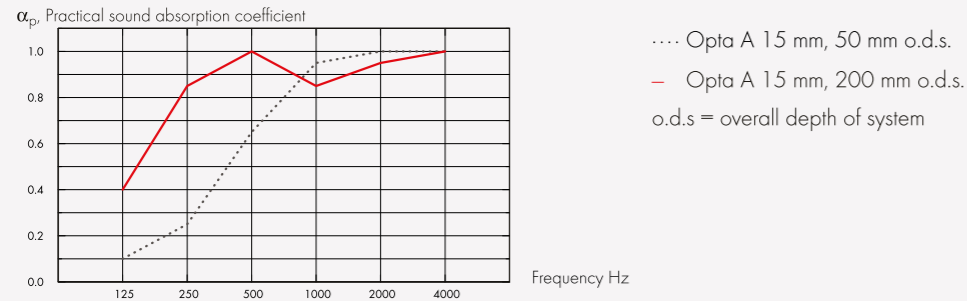

THK mm	o.d.s. mm	α_p , Practical sound absorption coefficient						α_w	Sound absorption class
		125 Hz	250 Hz	500 Hz	1000 Hz	2000 Hz	4000 Hz		
15	50	0.10	0.25	0.65	0.95	1.00	1.00	0.55	D
15	200	0.40	0.85	1.00	0.85	0.95	1.00	0.95	A

	THK mm	o.d.s. mm	NRC	SAA
-	15	50	0.75	0.74
-	15	400	0.85	0.87

THK mm	AC(1.5)
15	190

Articulation Class, ASTM E1111, ASTM E1110

Indoor Air Quality:

Certificate / Label	600x600, 1200x600 (NE)	Other formats
Eurofins Indoor Air Comfort®	IAC Gold	IAC
French VOC	A+	A
Finnish M1		•

Circularity: Minimum post-consumer recycled content: 53%, Recyclability: Fully recyclable,

Environmental Footprint: Life-cycle stages A1 to C4 from EPD, in conformity with ISO 14025 / EN 15804

	kg CO ₂ equiv/m ²
Opta A	1,48 [Opta family EPD in conformity with ISO 14025 / EN 15804]

Fire safety: A2-s1,d0 Europe: EN 13501-1, A2-s1,d0,

Humidity Resistance: Class C, relative humidity 95% and 30°C, according to EN 13964:2014

Visual appearance: White 190, nearest NCS colour sample S 1000-N, 80% light reflectance. Since the product has a coloured glasfelt as a surface, it can appear mottled, specially with indirect lighting. Slight colour differences can occur.

Cleanability: Weekly dusting and vacuum cleaning.

Accessibility: The tiles are easily demountable. Minimum demounting depth according to installation diagrams.

Installation: Installed according to installation diagrams, installation guides and drawing aid. (The tiles have to be installed according to the arrows on the back of the tile.)

System weight: The weight of the system (including suspension grid) should be approximately 2.5 kg/m².

Mechanical properties: See table about Max live load and Min load bearing capacity and Functional demands, Mechanical properties at www.ecophon.com.

CE: Ecophon ceiling systems are CE marked according to the European harmonized standard EN13964:2014. CE marked construction products are covered by a Declaration of Performance (DOP) which enables customers and users to easily compare performance of products available on the European market.

Installation diagram in detail www.ecophon.com

M360

Installation diagram (M360) for Ecophon Opta A

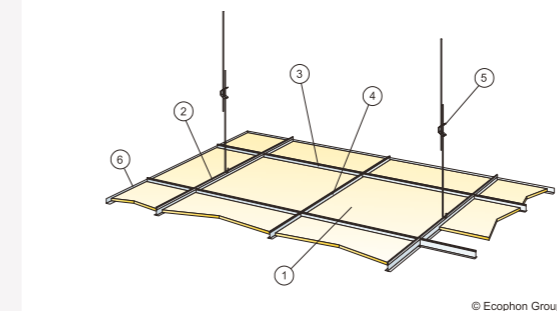

© Ecophon Group

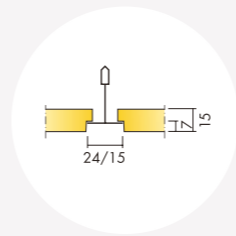

Ecophon Opta E

Acoustic:

Sound Absorption:

Test results according to EN ISO 354. Classification according to EN ISO 11654.

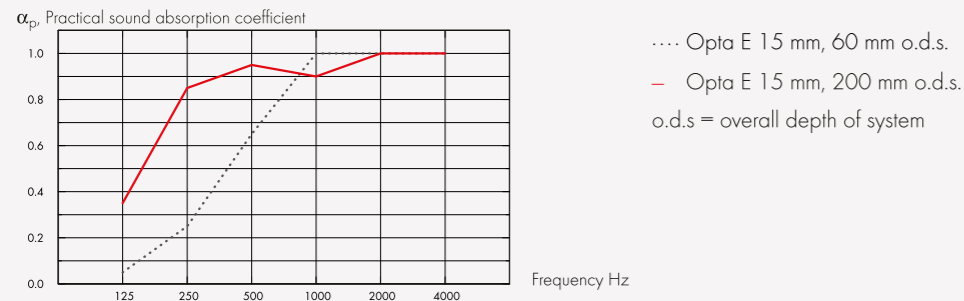

THK mm	o.d.s. mm	α_p Practical sound absorption coefficient						α_w	Sound absorption class
		125 Hz	250 Hz	500 Hz	1000 Hz	2000 Hz	4000 Hz		
15	60	0.05	0.25	0.65	1.00	1.00	1.00	0.55	D
15	200	0.35	0.85	0.95	0.90	1.00	1.00	0.95	A

	THK mm	o.d.s. mm	NRC	SAA
-	15	60	0.75	0.74
-	15	200	0.95	0.92

Indoor Air Quality:

Certificate / Label	600x600, 1200x600
Eurofins Indoor Air Comfort®	IAC Gold
French VOC	A+

Environmental Footprint: Life-cycle stages A1 to C4 from EPD, in conformity with ISO 14025 / EN 15804

	kg CO ₂ equiv/m ²
Opta E	2,03 [Opta family EPD in conformity with ISO 14025 / EN 15804]

Circularity: Minimum post-consumer recycled content: 51%, Recyclability: Fully recyclable,

Fire safety: The glass wool core of the tiles is tested and classified as non-combustible according to EN ISO 1182. Europe: EN 13501-1, A2-s1,d0,

Humidity Resistance: Class C, relative humidity 95% and 30°C, according to EN 13964:2014

Visual appearance: White 190, nearest NCS colour sample S 1000-N, 80% light reflectance. Since the product has a coloured glasfelt as a surface, it can appear mottled, specially with indirect lighting. Slight colour differences can occur.

Cleanability: Weekly dusting and vacuum cleaning.

Accessibility: The tiles are easily demountable. Minimum demounting depth according to installation diagrams.

Installation: Installed according to installation diagrams, installation guides and drawing aid. (The tiles have to be installed according to the arrows on the back of the tile.)

System weight: The weight of the system (including suspension grid) should be approximately 2.5 kg/m².

Mechanical properties: See table about Max live load and Min load bearing capacity and Functional demands, Mechanical properties at www.ecophon.com.

CE: Ecophon ceiling systems are CE marked according to the European harmonized standard EN13964:2014. CE marked construction products are covered by a Declaration of Performance (DOP) which enables customers and users to easily compare performance of products available on the European market.

Installation diagram in detail www.ecophon.com

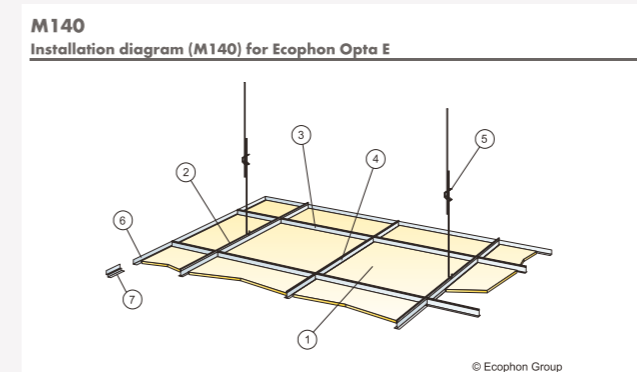



Ecophon is the leading supplier of indoor acoustic solutions that improve working performance and quality of life. We believe in the difference sound can make to our everyday lives, and are passionate advocates for the importance of room acoustics to people's wellbeing - whatever the space, activity or need.

Having a sound effect on people is the principle that guides all we do. We're proud of the Swedish heritage and human approach that promise is founded on. And, as members of the Saint-Gobain Group, to be doing our part in making the world a better home.

Saint-Gobain Ecophon AB

Box 500, SE-265 03 Hyllinge, Sweden

Phone: +46 (0)42 17 99 00

Fax: +46 (0)42 22 55 55

www.ecophon.com

SE556142516501 • Based in Åstorp